

Sense 2030 ultrasonic level transmitter

Non-Contact, Low Cost Ultrasonic Level Transmitter with a 4-20 mA current output.



Fig 1 Ultrasonic Level Meter contour map

Optional Outputs:

- **1-5 VDC.**
- **RS232C or RS485** direct computer connection.

Function:

Continuously monitors liquid level and provides a 4-20 mA current proportional to the level. Non-contact the liquid. The current signal

can be connected to a programmable controller, remote display, etc.

Features:

Non-Contact Sensing, No Maintenance, Switch Calibration, Easy Installation, Temperature Compensation, Automatic adjustment of beam width and gain.

Applications:

Diesel Fuel, Oils, Lubricants, Water, Slurries, Viscous Fluids, Acids, Caustics, etc.

Advantages of our Transmitter:

- * One piece, small size.
- * NEMA-4X outdoor housing.
- * Operates on 24 VDC power.
- * Provides smooth current output without surges.
- * Optional 316 stainless steel or Teflon® radiating face.
- * Repairable in field.

Calibration:

The calibration of current output is done by switches, one sets the 4 mA (or LOW) level, the other sets the 20 mA (or HIGH) level. As an option, it can be calibrated from a laptop or any computer with a serial port. We would be happy to pre-calibrate for you!

Exterior & joint size:

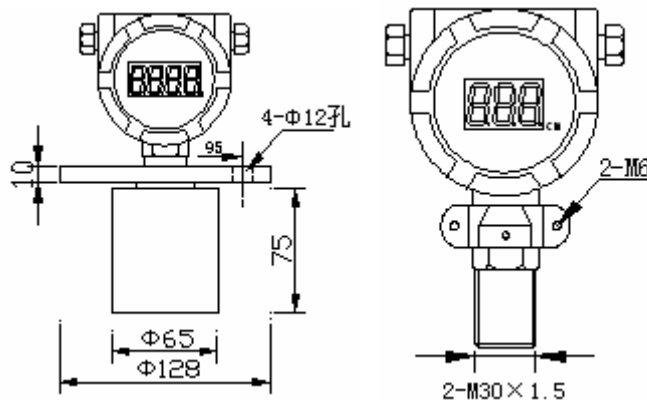

Fig 2

Ultrasonic Principle:

The transmitter operates using an ultrasonic echo, reflected from the monitored surface. The signal is directed perpendicularly toward the monitored surface. The time delay of the returned echo enables the internal microprocessor to determine the liquid level.

Operation (Sense2030-b/c/d):

Setting: Ultrasonic Level Meter output 4 mA in the Level L1 , output 20 mA in the Level L2. Only shorted Z-line and power (-), when the level is L1. Shorted F-line and power (-) , when the level reach L2. It should be noted that when you short-circuit F / Z line to the power(-), the lights of this equipment must be in a bright state.

OPERATION(sense2030-a/e/f):

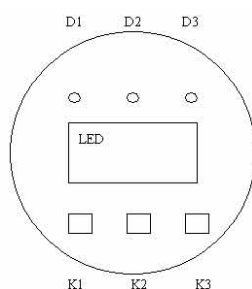

D1: lighting-in working

D2: lighting-in setting

D3: lighting-in echo ok

Fig 3

A1: calibrate 4mA or 0V change with K3 ↑ , K2 ↓

A2: calibrate 20mA or 5V change with K3 ↑ , K2 ↓

A3: distance in 4mA or 0V change with K3 ↑ , K2 ↓

A4: distance in 20mA or 5V change with K3 ↑ , K2 ↓

A5: measure distance in 0000,

 : measure level in max distance (range+deadzone),

 change with K3 ↑ , K2 ↓

A6: (option) switch level setup change with K3 ↑ , K2 ↓

A7: temperature display

Application Examples

The highest water level is 4.5(FS) meters, Level Meter installed in the 5.0(H) m height, the water level 0 m corresponding 4 mA, the water level 4.5 meters corresponding 20 mA.

First the Level Meter must be installed in the location higher than the highest water level 0.5(DZ) meters (Dead Zone) above.

Second, the distance between level meter and wall must not be less than range 1 / 10.

Third, there is not anything to shield off the sonic between level meter and bottom.

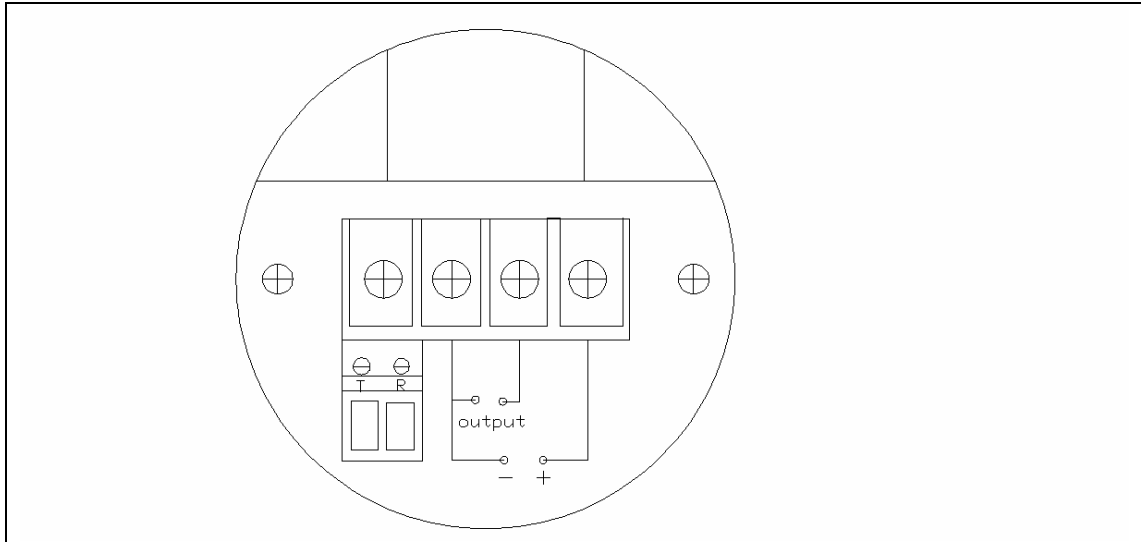

Fig4

The work done ,let's set the parameters.

1--wiring as Fig 4.Mistakes of wiring can cause damage to transmitter.

2--Access to power.

3--press K1,LED shows A1,check the 4mA(Connecting ammeter,change it to 4.000 with K2 and K3)

4--press K1,LED shows A2,check the 20mA(keep connecting ammeter,change it to 20.00 with K2 and K3)

5--press K1,LED shows A3,input 5.000(H,see above)with K2,K3
---4mA.

6--press K1,LED shows A4,input 0.500(DZ,see above)with K2,K3---20mA.

7--press K1,LED shows A5,input 5.000(the distance between level meter and bottom)with K2,K3.

8--press K1,LEDshows A6, input the numerical in there the switch

will be on or off .(option, otherwise, the void)

9--press K1,LED shows A7, then shows scene temperature.

10--press K1,LED shows A--,Completion is set into the work of state

If you want to measure distance,keep the step1,step 2,step 3,step 4,and input 0.500 in step 5,input 5.000 in step 6,input 0.000 in step 7,and keep the step 8,step 9,step 10.Then "4-20mA" will change according to distance .

When a rapidly changing level is detected, the transmitter will automatically increase the frequency of transmission and decrease the output damping for a faster response .Aside from calculating the current output proportional to the monitored level, the internal microprocessor performs the following:

- * Self-diagnostics and announces each received valid echo by a red LED light (D3) .
- * Signals any possible operating problems, such as loss of echo, level beyond the calibrated range, etc. using internal LED.
- * Upon an echo loss, the output will switch to a high, approximately 22 mA current.
- * Temperature compensating calculations.

SPECIFICATIONS:

Maximum Range (Tank Height):

sense2030 -5(-8, -10, -15) :5 (8, 10, 15)meters

Output:4-20 mA , 500 Ohm, sourcing

Optional Outputs:• 1-5 VDC • RS232C. RS485.

Accuracy: +/-0.3% of span (in air)

Repeatability: +/-0.1% of span

Resolution: 1 mm, 1cm

Power: 12 to 24 VDC, 0.1 Amps .Green LED :Power-On indication.

Wiring:2 power wires + 1 current output wire.

Enclosure:Al housing, NEMA-4X type Length: 150 mm

Beam: Nominal 15-degrees, 300~500 mm blind zone.

Automatically adjusts beam width and signal

strength. (sense2030-8, -10

&-15)

Operating Temperature:-30°

C to 80° C







Optional Signal Face:316 stainless steel or Teflon®

Joint size & display:

Sense 2030-a/c: M30*1.5. Sense2030-b:M62*2;

Sense2030-d:M60*2; Sense2030-f:DN50 flange

Models on the list

| Models | Sense2030 -a | Sense2030 -b | Sense2030 -c | Sense2030 -d | Sense2030 -e | Sense2030 -f |
|--------------------|---|---|---|---|---|---|
| Appearance |  |  |  |  |  |  |
| display | 3 1/2 LED | No | No | No | 4 LED | 4 LED |
| Output | 4-20mA | 4-20mA Option: 1switch Pnp | 4-20mA Option: 1switch Pnp | 4-20mA Option: 1switch Pnp | 4-20mA Option: RS485/232; 2switch: pnp output | 4-20mA Option: RS485/232; 2switch:pnp output |
| Setting up | set with 3 keys in scene | Set with 2 wires in scene | Set with 2 wires in scene | Set with 2 wires in scene | Set with 3 keys in scene | Set with 3 keys in scene |
| Wiring | Third-line system | Fifth-line system | Fifth-line system | fifth-line system | third-line system | Third-line system |
| Applica-tion | All-weather Outdoor Water Weak corrosive IP 65 Low price | All-weather Outdoor Water /powder Weak corrosive IP68 Low price | All-weather Outdoor Water Weak corrosive IP68 Low price | All-weather Outdoor Water /powder/ Corrosive liquid IP 68 | All-weather Outdoor Water/oil corrosive liquid IP65 | All-weather Outdoor Water /oil/ Corrosive liquid IP 65 |
| Range | 0.5-5m | 0.5-3,5m | 0.5-5,8,10 m(p)# | 0.5-3,5,8m(p) # | 5,10,12,15m | 5,10,12,15m |
| Installat-ion size | M30*1.5 | M30*1.5 L=110 | M60*2 L=90 | M30*1.5 L=150,Max Dia: Φ 80 | M62*2 | DN50 flange |
| Forbid | Steam,dust,pressure vessels,vacuum vessels #:(p):means solid powder | | | | | |

Shenyang Yinuo Science & Technology Co., ltd

Room 1410, No.63, Middle Road Chongshan, shenyang. China

Our websete:www.china-sense.com e-mail:shuiyibiao@163.com

Tel:0086+24+86244743/86231499 e-mail: sales@china-sense.com